

TSR-3386

玻璃釉微調電位器

■ 單圈的/金屬陶瓷/工業用/密封
 ■ (Single Turn/ Cermet/ Industrial/ Sealed)

■ 多種引線的安裝尺寸
 ■ (Many Terminal Styles)

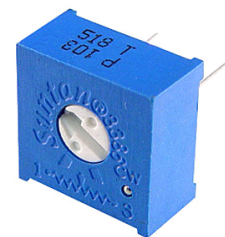

電氣特性 Electrical Characteristics

| | |
|--|--------------------------------|
| 標稱阻值範圍 Standard Resistance Range | 10Ω - 5MΩ |
| 阻值允許偏差 Resistance Tolerance | ±10% (±20% only for 10 ohm) |
| 終端電阻 Absolute Minimum Resistance | ≤1% R 或 10n |
| 接觸電阻變化 Contact Resistance Variation | CRV≤3% |
| 絕緣電阻 Insulation Resistance | RI≥1GΩ(100Vac) |
| 耐電壓 Withstand Voltage | 600Vac |
| 有效行程 Effective Travel | 300° ± 10° |

環境特性 Environmental Characteristics

| | |
|--|--|
| 額定功率 Power Rating (315volts max) | 0.5W@70°C, 0W@125°C |
| 溫度範圍 Temperature Range | -55°C ~ +125°C |
| 溫度系數 Temperature Coefficient | General offer ±250 ppm/°C (±100ppm/°C is available if request.) |
| 溫度變化 Temperature Variatio | -55°C, 30min, +125°C 30min, 循環 5 次 5 cycles ΔR≤5%R, Δ(Uab/Uac)≤10% |
| 碰撞 Collision | 100m/s ² , 4000cycles, ΔR≤2%R |
| 70°C 耐久性 Electrical Endurance at 70°C | 0.5W@70°C, 1000h ΔR≤10%R Δ(Uab/Uac)≤10%, CRV≤3% or 5Ω |
| 機械壽命 Rotational Life | 200 周 (200 cycles) ΔTR≤10%R, CRV≤3% or 5n |

物理特性 Physical Characteristics

| | |
|----------------------------|--|
| 起動力矩 Starting orque | ≤35mN·m |
| 標誌 Marking | 阻值允許偏差(±10%不標注) 阻值代碼-產品型號 Resistance Tolerance Resistance Code, Model (When no identification, it is of ± 10%) |
| 標準包裝 Standard Packaging | 50 只/管 (50pcs, per tube) |

共有尺寸 Common Dimensions

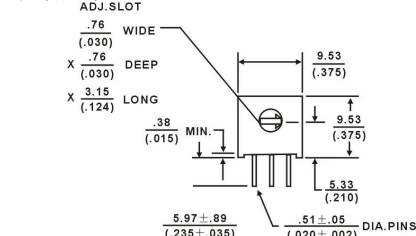

TSR-3386B

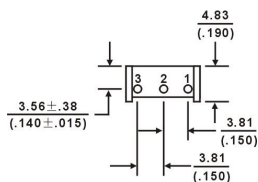

TSR-3386C

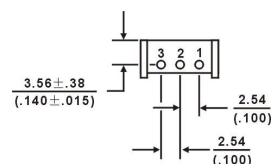

TSR-3386H

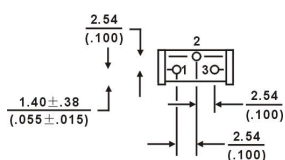

TSR-3386J

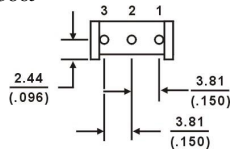

TSR-3386S

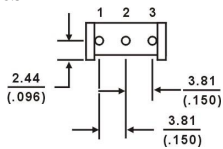

TSR-3386W

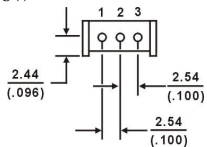

TSR-3386X

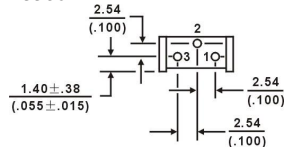

訂購指南 How to Order

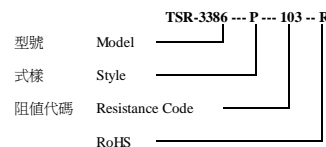

電刷 WIPER 2(d)

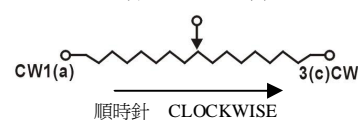

圖中公差：除注明外均為±0.25
 Tolerance is ±0.25 if no identification

阻值代碼表

Standard Resistance table

| Resistance(Ohms) | Resistance Code |
|------------------|-----------------|
| 10 | 100 |
| 20 | 200 |
| 50 | 500 |
| 100 | 101 |
| 150 | 151 |
| 200 | 201 |
| 250 | 251 |
| 300 | 301 |
| 470 | 471 |
| 500 | 501 |
| 680 | 681 |
| 1,000 | 102 |
| 1,500 | 152 |
| 2,000 | 202 |
| 2,200 | 222 |
| 2,500 | 252 |
| 3,000 | 302 |
| 4,700 | 472 |
| 5,000 | 502 |
| 6,800 | 682 |
| 10,000 | 103 |
| 15,000 | 153 |
| 20,000 | 203 |
| 22,000 | 223 |
| 25,000 | 253 |
| 30,000 | 303 |
| 33,000 | 333 |
| 47,000 | 473 |
| 50,000 | 503 |
| 68,000 | 683 |
| 100,000 | 104 |
| 150,000 | 154 |
| 200,000 | 204 |
| 220,000 | 224 |
| 250,000 | 254 |
| 300,000 | 304 |
| 330,000 | 334 |
| 470,000 | 474 |
| 500,000 | 504 |
| 680,000 | 684 |
| 1,000,000 | 105 |
| 2,000,000 | 205 |
| 2,200,000 | 225 |
| 5,000,000 | 505 |

可按用戶要求提供特殊規格
 Special resistances available.

TSR-3386

共有尺寸 Common Dimensions
頂調式

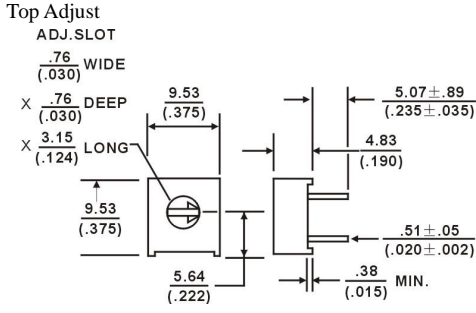

TSR-3386F

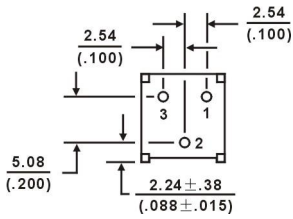

TSR-3386K

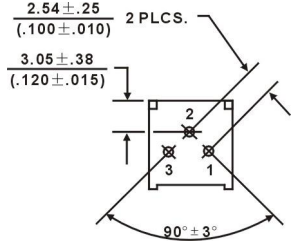

TSR-3386M

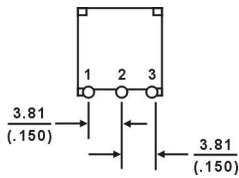

TSR-3386P

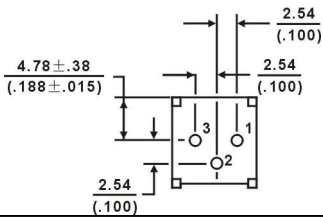

TSR-3386R

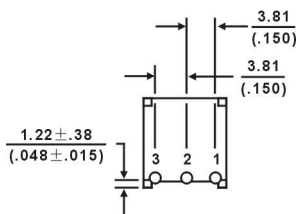

TSR-3386T

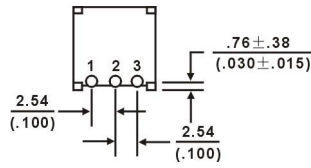

TSR-3386U

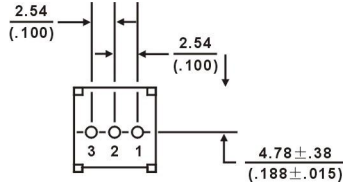

TSR-3386Y

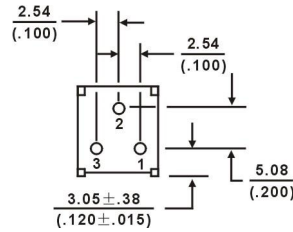

TSR-3386G

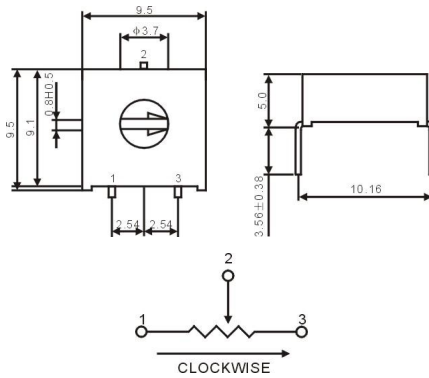

TSR-3386V

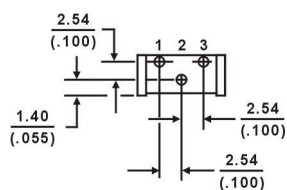
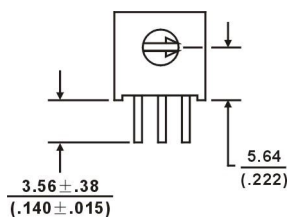

TSR-3386(STYLE) -EY5-(RESISTANCE CODE)
Side Adjust

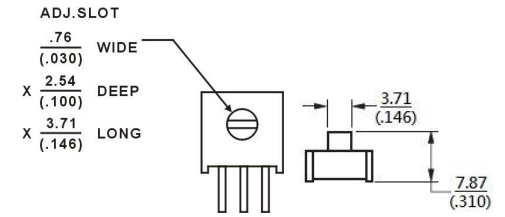

Top Adjust

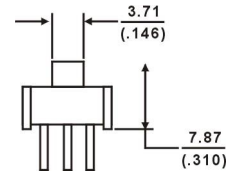

TSR-3386(STYLE)-EY5-(RESISTANCE CODE)-T

The Model 3386 is available with a knob for finger adjustment. Add suffix letter "T" to order code.

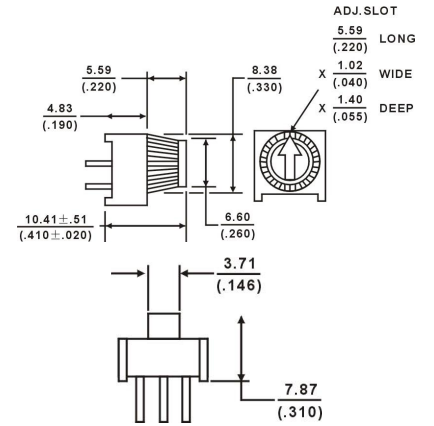

TSR-3386F,K,P,R,U,Y-EY5 (RESISTANCE CODE)-L

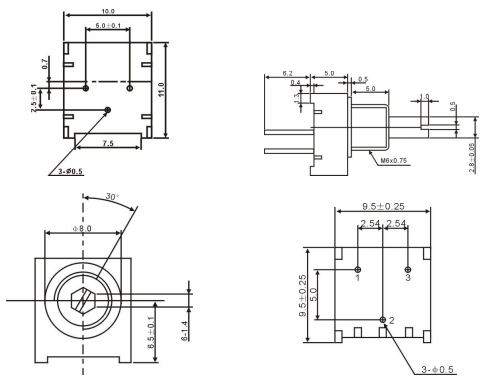

TSR-3386F,K,P,R,U,Y-EY5 (RESISTANCE CODE)-TL

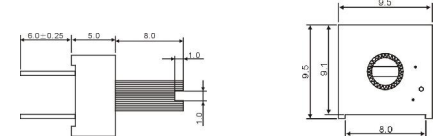

Note: Specification are subject to change without notice. For more detail and update, please visit our website.